



Serial No. 385

Document No. 25

ANNUAL MEETING - JUNE 1956Compilation of Research Reports by Subareas, 1955

By Erik M. Poulsen

Summaries of researches carried out in 1955 were reported by the following countries: Canada, Denmark, France, Iceland, Norway, Portugal, Spain, United Kingdom and United States. The table below shows the distribution of researches by subareas and countries (xx indicates researches from special research vessels, x only observations made by observers on other state vessels or on commercial fishing vessels):

| <u>Subarea</u> | <u>1</u> | <u>2</u> | <u>3</u> | <u>4</u> | <u>5</u> |
|----------------|----------|----------|----------|----------|----------|
| Canada | | | | | |
| Denmark | xx | xx | xx | xx | |
| France | x | x | x | x | x |
| Iceland | x | | | | |
| Italy | | | | | |
| Norway | x | | | | |
| Portugal | x | x | x | | |
| Spain | | | x | | |
| United Kingdom | x | | | | |
| United States | x | x | x | xx | xx |

Of the researches carried out by France, Iceland and United Kingdom only the extent and not the results have been reported up to date.

The Subareas 1 and 3 are those in which more extensive research work has been carried out by more than one country and therefore those mainly to be considered in this compilation. The extensive researches in Subarea 5 are all (apart from some observations by surface temperatures made by France) carried out by United States. (Vide U.S.A. Research report Document No. 4.)

SUBAREA 1

Research vessel "Dana" (Denmark), July-August.
 Research cutters "Adolf Jensen", "Tornaq" and "Immanuel" (Denmark), over the year.
 Frigate 1 "Aventure" (France), summer.
 Commercial fishing vessel (Iceland), summer.
 Commercial fishing vessel (Norway), summer.
 Hospital ship "Gil Eannes" (Portugal) June-September.
 Commercial fishing vessels (Portugal), summer.
 Commercial fishing vessel (U.K.)
 Hydrographic observations (U.S.A. Coast Guard).

A. Hydrography

6 sections from the coast between Frederikshab and Hare Island across the fishing banks to 58-59°W. Long. July (Denmark).
 1 section Cape Farvel-Hamilton Inlet Bank. July (Denmark).
 1 section Faroes-East Greenland. July (Denmark).
 1 section Cape Farvel-Iceland. August (Denmark).

...../2.

1 section across the Davis Strait (66°N), observations of surface temperatures up to 68°N (France); results not yet reported.
3 sections across Fylla Bk., S, and N. Lille Hellefiske Bk. August (Norway).
Hydrographic observations Newfoundland-Kap Farvel (U.S.A.), results not reported.

All reports state the ice conditions to be unusually severe in 1955. The Danish sections accordingly show comparatively low temperatures on and near Fyllas Bank. Farther north (Lille and Store Hellefiske Bks.) temperatures about normal or even a little higher than normal were found.

This change in hydrographic conditions from 1954 to 1956 is illustrated by Figures 1-4.

1A and 1B show for the eastern part of the Danish Fylla Bk. section the temperatures in the water layers down to 300 m. on 21 July 1954 (A) and on 21 July 1955 (B). The water layers with temperatures of more than 3°C (3-5°) are vertically striated, the layers with temperatures below 1°C. (-0.2 to +1°) are horizontally striated.

In 1954 water with temperatures from 3 to 4.8° covered most of the surface layer down to ca. 50 m. depth and also the area over deep water to the west of the bank up to ca. 75-200 metres. In 1955 water with this temperature was not found at all in the surface layers, where the temperature was from 1 to 2.8°. Over the deep west of the bank water of more than 3° only reached upwards to about 250 m. from the surface. In 1954 cold water, 0 to +1°, was only found as a tongue on the western slope of the bank. In 1955 such cold water was found in a belt from the bank and westwards between 20-50 m. and 100-180 m. In the western part a tongue of below zero water was present. The curved lines in Fig. 1C show the change in temperature from 1954 to 1955. Only in a small area on the inner and outer slope of the bank (++) the temperature was higher in 1955 than in 1954, everywhere else lower. The decrease in temperature is greater in the open water west of the bank than on and around the bank.

Fig. 2, A, B, and C, from the Norwegian section over the N. part of Lille Hellefiske Bank, shows that in this more northern region the temperature is not lower in 1955 than in 1954. Lower temperatures were only found in two small patches of surface water and in a small patch close to the bottom. Everywhere else the temperature was higher in 1955 than in 1954; however, the difference is only small, up to 1.7°.

A comparison of the temperature in the upper layers of the western part of the Danish Fylla Bank section in 1954 and 1955 (Fig. 3, A and B) shows that the decrease in temperature occurs not only on the banks but also in the area west of the bank. This indicates that the decrease is due not only to an increase of the Arctic component of the E. Greenland current, but also to an eastward expansion of the Labrador current. For the western part of the more northern section across Lille Hellefiske Bank (Fig. 4), a decrease in temperature from 1954 to 1955 occurs only in the upper 40 metres, where the temperature in 1954 was 2-5°, against in 1955 only 1-3°. The question of the expansion of the Labrador current cannot be studied more closely, as hydrographic observations have not been reported from the region off the Canadian east coast, north of Hamilton Inlet Bank.

...../3.

B. Cod. The numbers of cod larvae (caught in July by 2m. stramin net from "Dana") were very small, as in the previous year. The numbers caught per 30 minutes were as follows for the years 1950-1955:

| <u>Year</u> | <u>1950</u> | <u>1951</u> | <u>1952</u> | <u>1953</u> | <u>1954</u> | <u>1955</u> |
|-----------------|-------------|-------------|-------------|-------------|-------------|-------------|
| No. per 30 min. | 8 | ? | 1.6 | 4.1 | 1.3 | 1.3 |

It is in good accordance with these variations in amount of larvae that within this period the year-classes 1950 and 1953 are (according to the Danish Research Report) rich year-classes.

Special Danish researches on the abundance of young cod in near coastal waters and in fjords showed that among the youngest year-classes the 1953 year-class is rich. It might be of interest to have these investigations with small meshed gears expanded to include part of the bank areas.

As in previous years, a most efficient sampling of cod was carried out. Samplings were reported by Denmark, Norway and Portugal. Samplings of commercial cod were also carried out by Iceland and United Kingdom, but the results have not yet been reported. (Results from Germany have just now been reported.)

From the Danish report it is of interest to note that the rich 1950 year-class now is strongly represented in the catches, especially in the northern area. In the Portuguese samples this young year-class still is scarce, however less in the north than in the south. In all the Norwegian samples the 1950 year-class is scarce. The dominant year-class in the Norwegian and Portuguese fisheries is the 1947, followed by the 1945 and 1942.

Fig.5 shows the age-distribution of cod sampled in 1955 (ca. 11,000 spec.) in the various subdivisions (A-F) of Subarea 1. The figure is compiled from the separate samples reported by Denmark, Norway and Portugal (the other countries sampling the subarea have not reported the data from their samples).

Subdivision 1A, the most northern subdivision, differs from the other subdivisions by the very pronounced dominance of the old, rich 1942 year-class, which still makes up 36%; in the other subdivisions it does not exceed 13%.

In the other subdivisions the rich 1947 year-class dominates (30-40%); it is followed by the 1950, 1945 and 1942 year-classes. The young rich 1950 year-class is especially rich in subdivision B and D. It is of interest to note that the 1949 year-class is the next rich one in subdivision E; for the other subdivisions it must be noted as poor. Its high % in this subdivision is caused by a high frequency % in two samples from near coastal waters.

The diagram of the age distribution from the whole Subarea 1 shows the absolute predominance of the 1947 year-class (38%); next comes 1950 with 12%, 1942 and 1945 with respectively 9.3 and 8.9%.

C. In accordance with decision of Panel 1, halibut researches have been commenced in Subarea 1, and a number of taggings have been carried out by Norway.

...../4.

SUBAREA 2

Research vessel "Investigator II" (Canada), July-August
Research vessel "Dana" (Denmark), July
Frigate 1 "Aventure" (France), summer
Commercial fishing vessel (Portugal), summer
Hydrographic observations (U.S.A. Coast Guard)

A. Hydrography

1 section across Hamilton Inlet Bank, July-August (Canada)
1 section Hamilton Inlet Bank-Cape Farvel, July (Denmark)
Hydrographic observations in offshore waters (France).

On the Hamilton Inlet Bank and closer to the coast, the volume of water below 0°C. was much smaller in 1955 than in 1954. (See Fig.5). Also the Danish section from the first half of July shows a considerably smaller mass of cold water over the eastern slope of the bank in 1955 than in 1954 (Fig.7).

The only country which has reported biological work from Subarea 2 is Portugal. Four samples of cod were collected from trawlers. The year-classes 1947 and 1945 dominate in the samples, i.e. year-classes which also are rich in W. Greenland waters; however the difference between richer and poorer year-classes is far less pronounced in Subarea 2 than in 1.

Fig.8 shows a comparison of the age-distribution of the trawl-caught cod in 1955 from Hamilton Bk. with trawl-caught cod from Subarea 1 (Fyllas Bk.) also by Portuguese vessels, and from Subarea 3 (southern Grand Bank), Spanish vessel.

The length-distribution curve shows a peak between 50 and 55 cm., in W. Greenland waters the peak is between 70 and 75 cm. This indicates a far slower growth in the waters off Labrador than in those off W. Greenland. This also appears from a comparison of mean lengths of age-groups (from Portuguese samples):

| | <u>W. Greenland</u> | <u>Labrador</u> |
|----------------------------------|---------------------|-----------------|
| Age Group VIII (year-class 1947) | 68-71 cm. | 52.8 cm. |
| " " X " " 1945 | 75-80 cm. | 55.3 cm. |

SUBAREA 3

Various research vessels (Canada), over the year
Frigate 1 "Aventure" (France), spring, autumn
Hospital ship "Gil Eannes" (Portugal), spring-autumn
Commercial fishing vessels (Portugal), spring-autumn
Commercial fishing vessel (Spain), June-July
Samplings and hydrographic obs. (U.S.A), over the year

A. Hydrography

Sections across S. Grand Bank and St. Pierre Bank, April (Canada)
5 sections from the coast across the Grand Bank, July-Aug. (Canada); data from one of these reported to the Commission.
Observations on the Grand Bank (France), over the year.
Observations in connection with commercial fishery (Spain), June-July.

...../5.

Close to the Newfoundland east coast (Avalon Channel) and on the central part of the Grand Bank, temperatures were not as low as in 1954. Along the N.E. and S.W. slope of the Bank there were greater amounts of cold water in 1955 than in 1954.

These differences between the two years are illustrated by Fig.9 in which the Canadian sections St. John's-Flemish Cap, for the years 1954 and 1955, are shown together. The water mass below $+ 1^{\circ}\text{C}$. in the Avalon Channel (the coastal branch of the Labrador current is considerably larger in 1954 than in 1955, reaching further east and closer to the surface. Over the east slope of the Grand Bank the branch of the Labrador current is of the same dimensions in the two years, but the warmer water $2-3^{\circ}\text{C}$ is a little closer to the bank in 1954 than in 1955. The waters of the surface layer are decidedly warmer in 1954 ($12-13^{\circ}$) than in 1955 ($8-11^{\circ}$). It seems that the weakening of the Labrador current in coastal waters is followed in 1955 by a spreading of cold water towards the east. This expanding to the east of the Labrador current was also observed in 1955 in Subarea 1 (Fig.3, A and B).

B. Haddock

The rich 1949 year-class still dominates the catches of the Canadian fishery. The 1952 year-class was plentiful on the S.E. Grand Bank and moderate numbers of the 1953 year-class were present here. (Extensive Spanish samplings have just now been reported.)

C. Cod

Considerable tagging experiments were carried out by Canada.

Commercial samples of cod from the southern part of the Grand Bank were measured and aged by Spain. The size-curve shows a peak between 56 and 65 cm. The 6-year old fish - the rich 1949 year-class - make up the bulk of the cod (29%), just as it did in 1954 (33%); in 1953 it was the next rich year-class (18%). Accordingly the cod caught by the Spanish vessels has increased in size over the last 3 years:

| | | |
|------|---|----------|
| 1953 | - | 43.7 cm. |
| 1954 | - | 54.4 cm. |
| 1955 | - | 57.2 cm. |

The age-distribution of the Spanish sample is shown in Fig.8 together with corresponding samples from Subareas 1 and 2. In the samples from Subareas 2 and 3 is not found that striking difference in strength of year-class known from Subarea 1. The sample from the Grand Bank shows almost the same frequencies for the age-groups IV, V and VI. The mean age of the cod in the sample from the Grand Bank is far below that in the samples from Subareas 1 and 2.

A series of samples have been taken on board Portuguese dory vessels and trawlers; the results have not been reported yet.

D. Redfish

Considerable samplings of redfish have been carried out from Canada. Special samplings of quite small redfish over 2 years have verified the very slow growth:

| | | | |
|----------------|---|----------|----------|
| Dec. 1953 | - | 7.1 cm. | |
| Dec. 1954 | - | 9.0 cm. | |
| Oct.-Nov. 1955 | - | 11.8 cm. |/6. |

Thus the growth is only about 2 cm. a year. The group sampled is born either in 1951 or in 1952.

E. American Plaice

Recaptures from a large Canadian tagging experiment in 1954 show only inconsiderable migrations.

SUBAREA 4

Various research vessels (Canada), over the year
Various commercial vessels (Canada), over the year
Frigate 1 "Aventure" (France), over the year
Various research vessels (U.S.A.), over the year
Various commercial vessels (U.S.A.), over the year

A. Hydrography

Three seasonal surveys of Bay of Fundy, Scotian Shelf, and Gulf of St. Lawrence (Canada). Results from the Scotian Shelf (section off Halifax) reported to the Commission. Analyses of surface water at six coastal stations (Canada), over the year.

Over the Scotian Shelf the surface layer was warmer than in 1954, but the temperature of the cold water below was lower in 1955 than in 1954. These changes are illustrated in Fig. 10, A and B, in which the upper part of the section for the two years 1955 and 1954 are compared. It appears from the figures that the water mass close to the coast with a temperature of below 3°C. (striated in the Fig.), stretches farther down and farther east in 1955 than in 1954; also the waters over the Emerald Bank are colder in 1955 than in 1954.

B. Haddock

The Canadian researches were centred on the study of the validity of the otolith method for ageing. Its validity was proved also by the observation that the rich year-classes can be followed from year to year as peaks on the size-distribution curves.

C. Cod

Population studies (Canada) showed that the post-war change from line-fishing to trawl-fishing has caused a decrease in size of cod, which now is below the optimum for maximal landings.

The taggings were continued. The results from the last years taggings are reported in table form. They show the following percentages of recoveries:

after 1½ years - 25, 34, 36, 43, 45 and 48%
after 2½ years - 30, 35, 55, and 65%.

Studies of mesh selection and of effect of chafing-gear were carried out for cod and haddock.

D. Redfish

Growth and maturity were studied (Canada), especially in the Gulf of St. Lawrence. Growth is faster for females than for males.

...../7.

E. Halibut landing statistics were studied. A considerable number of small halibut are caught by vessels fishing for other species. Through reduction of these catches of small halibut, it may be possible to increase total halibut landings.

The study of the halibut fisheries and the stocks has now been initiated over wide regions of the Convention Area (Subareas 1 and 4). A co-ordination of the methods in use by the various nations would be advisable in order that results can be reached which could form a base for an adequate protection of the stocks.

F. Studies of the distribution of fish eggs and larvae were continued by Canada in most of Subarea 4.

As a negative feature of the research reports has to be mentioned, that none of the European countries fishing in Subarea 4 has sampled its commercial catches. As the European fleets fish a considerable part of the cod in Subarea 4, it is desirable that such samplings be carried out, to be compiled and compared with Canadian samples, when reported.

SUBAREA 5

Researches in this subarea were carried out only by U.S.A. They were, as in earlier years, centred on haddock and redfish, but considerable attention was also paid to hakes and flounders. Special researches were made on the distribution of fish eggs and larvae. Experimental fishing for the location of new stocks of marketable fish was carried out in deeper water in the subarea.

As no other country undertakes researches in the subarea, no compilation is necessary. The U.S.A. Research Report is circulated as Meeting Document No.4.

Hydrography of Whole Area and of Adjacent Areas

Fig.11 shows the temperatures ($^{\circ}\text{C}$) in 50 metres depth over the Convention Area. The figures is compiled from sections taken in July-August and reported by Canada, Denmark and Norway.

Off the south and SE coast of Greenland the temperature at 50 m. was decidedly lower in 1955 than in 1954 (see Fig.12). The 7° isotherm is farther away from Cape Farvel in 1955 than in 1954. An appreciable tongue of below zero water penetrates in 1955 from Cape Farvel in offshore water north to off Godthåb in an area where in 1954 temperatures between 2 and 3° were found. Further in 1954 the cold waters of the Labrador current and those of the Greenland coastal waters were separated by a mass of water over $+2^{\circ}\text{C}$. This is absent in 1955 and water below $+1^{\circ}$ "unites" the two water masses.

Fig.13 shows the smaller extension of zero water at 50 m. depth in 1955 compared to 1954 just to the east of Newfoundland, mentioned in the Canadian Research Report.

Attached to the Danish Research Report are figures showing temperature and salinity of two trans-Atlantic sections, from the Faroes to SE Greenland and from Cape Farvel to the English Channel.

The research report states that the Polar current to the SE of Greenland is of greater volume in 1955 than usual, and that the sharp front between the cold sub-Arctic water and the warmer

...../8.

Atlantic water is - as in 1954 - situated in the SW part of the trough between the Reykjanes Ridge and the Mid-Atlantic Ridge at about the same longitude as in 1954.

Thus one may conclude that the decrease in water temperature off S and SW Greenland is a more local phenomenon (caused by a strengthening of the East Greenland Polar current), and not caused by changes in the mid-Atlantic Gulf Stream area. We might, therefore, hope that it is just a yearly oscillation and not an indication of a widely ranged climatic change.

--ooOoo--

Fig.1 - Temperature in the E. part of the Danish Fylla Ek. section, 1954 and 1955

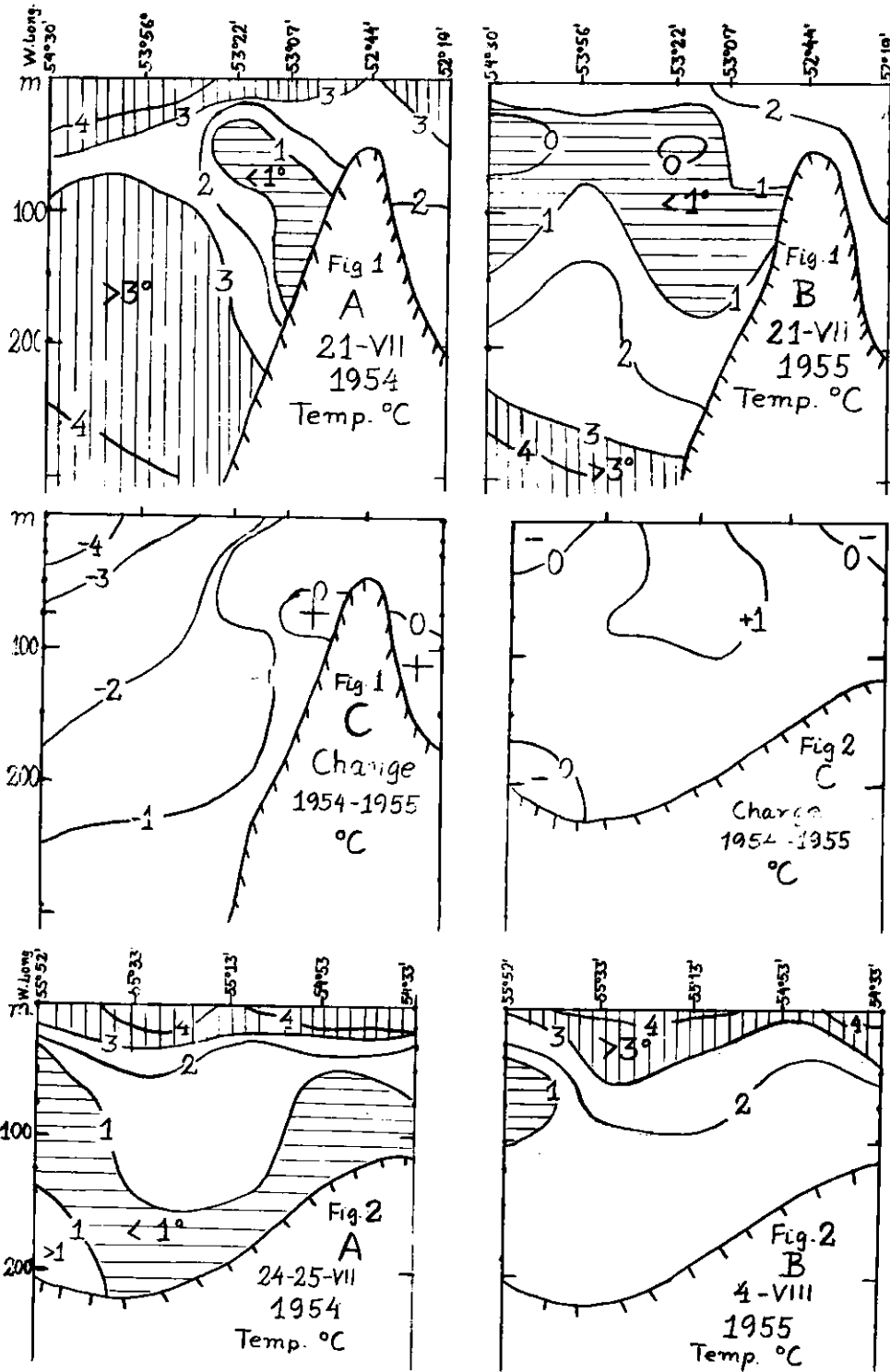

Fig.2 - Temperature in the Norwegian section across N. part of Lille Hallefiske Ek., 1954 and 1955.

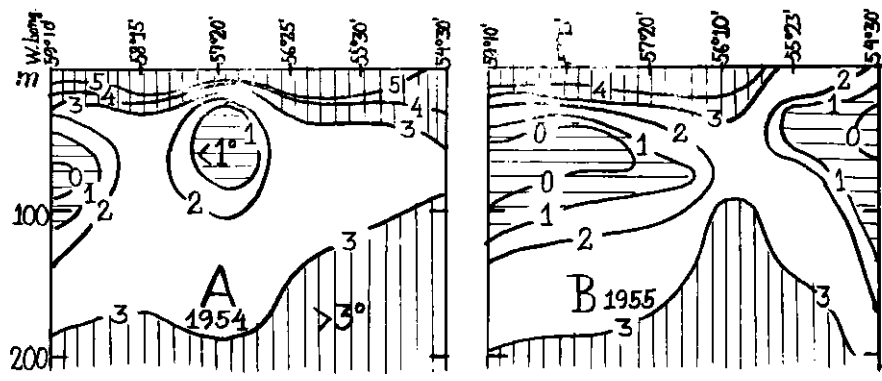

Fig.3 - Temperature in W. Part of the Danish Fylla Ek. section, A-1954, B-1955

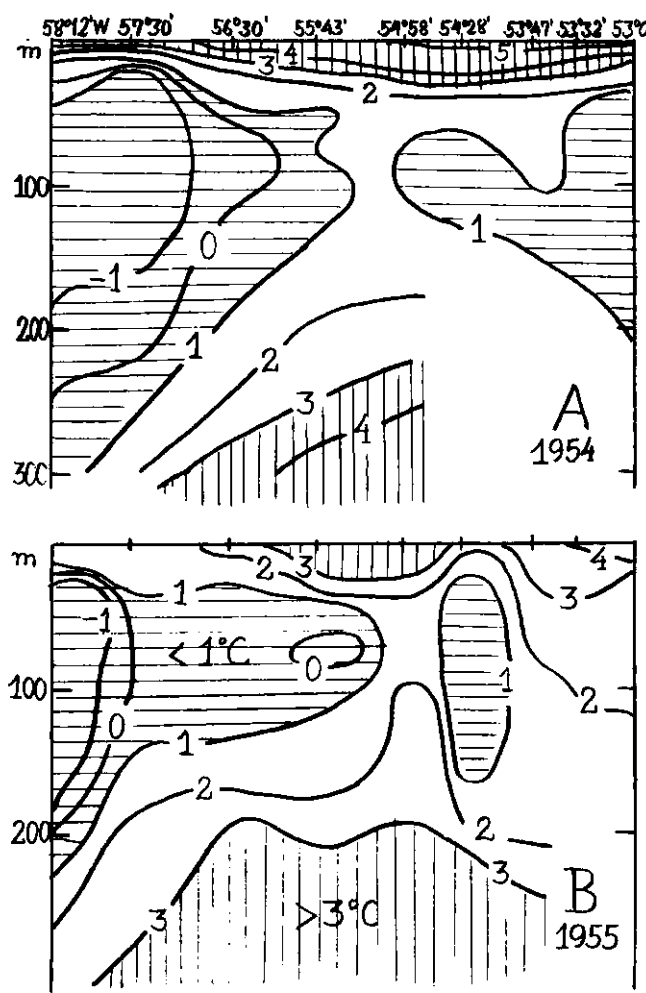

Fig.4 - Temperature in W. Part of the Danish Lille Hellefiske Ek. section, A-1954, B-1955.

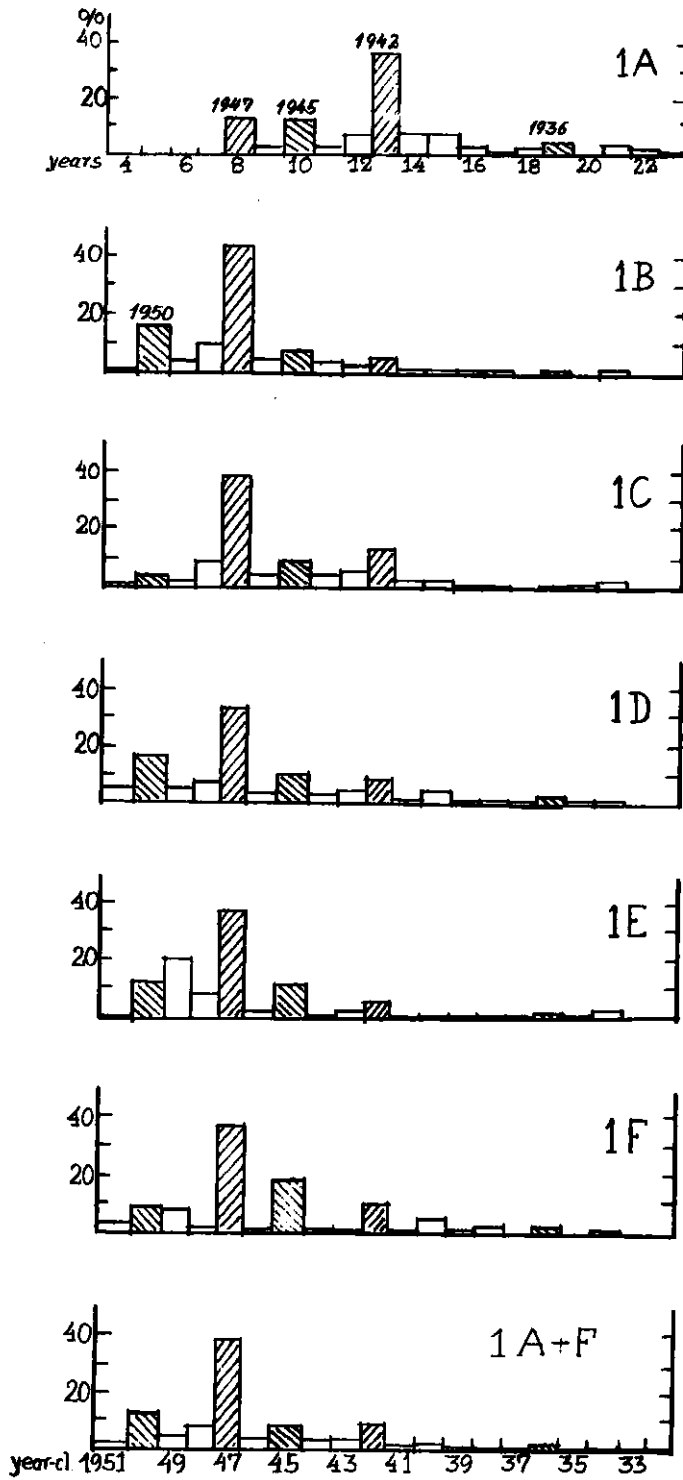

Fig.5 - Age-distribution of cod in the various sub-divisions of Subarea 1 in 1955 compiled from Danish, Norwegian and Portuguese samples.

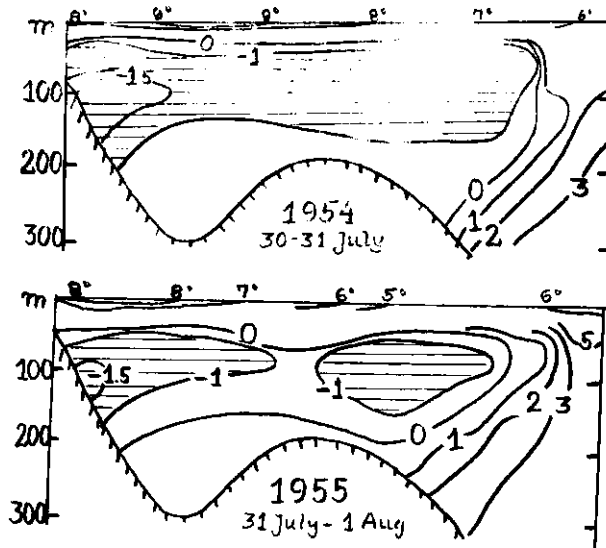

Fig.6 - Temperature in the Canadian section across Hamilton Inlet Bk., 1954 and 1955.

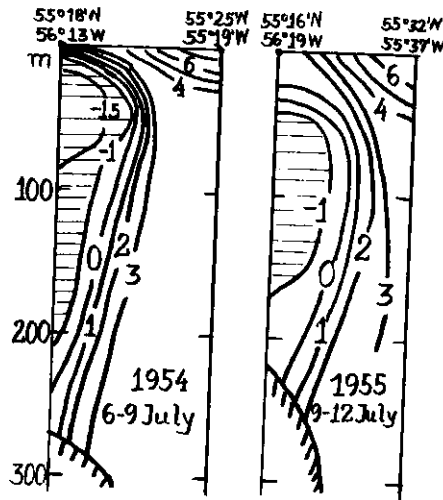

Fig.7 - Temperature in the westernmost part - over the slope of the Hamilton Bk. - of the Danish section Labrador-Greenland, 1954 and 1955.

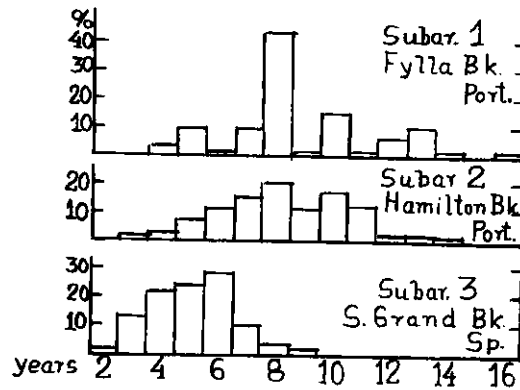

Fig.8 - Comparison of age-distribution of trawl-caught cod in 1955, Subarea 1, 2 (Portuguese samples), and 3 (Spanish samples).

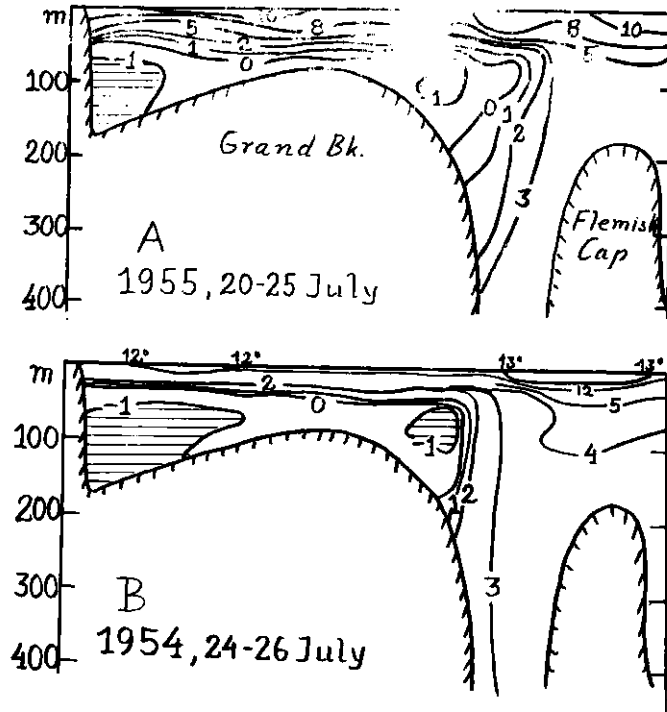

Fig-9 - Temperature in Canadian section across the Grand Bank, 1955 and 1954.

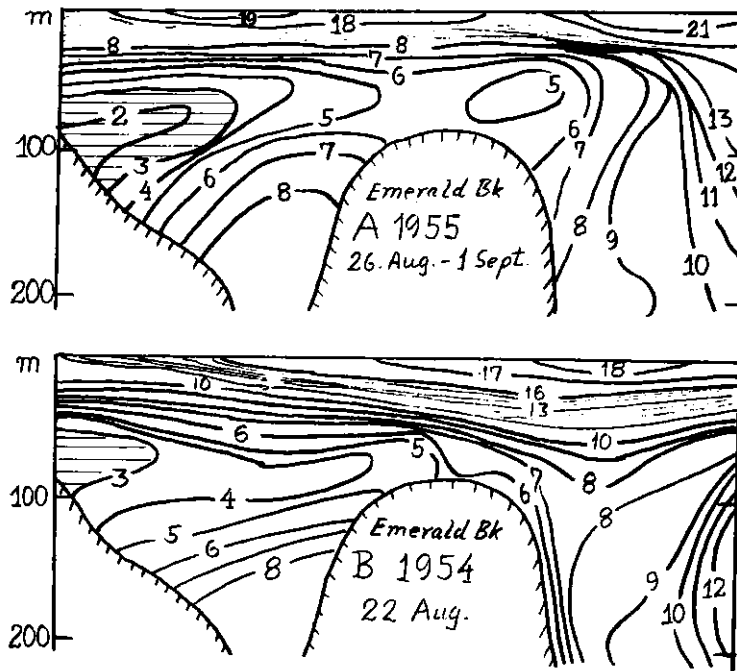

Fig.10 - Temperature in Canadian section across the Scotian Shelf, 1955 and 1954.

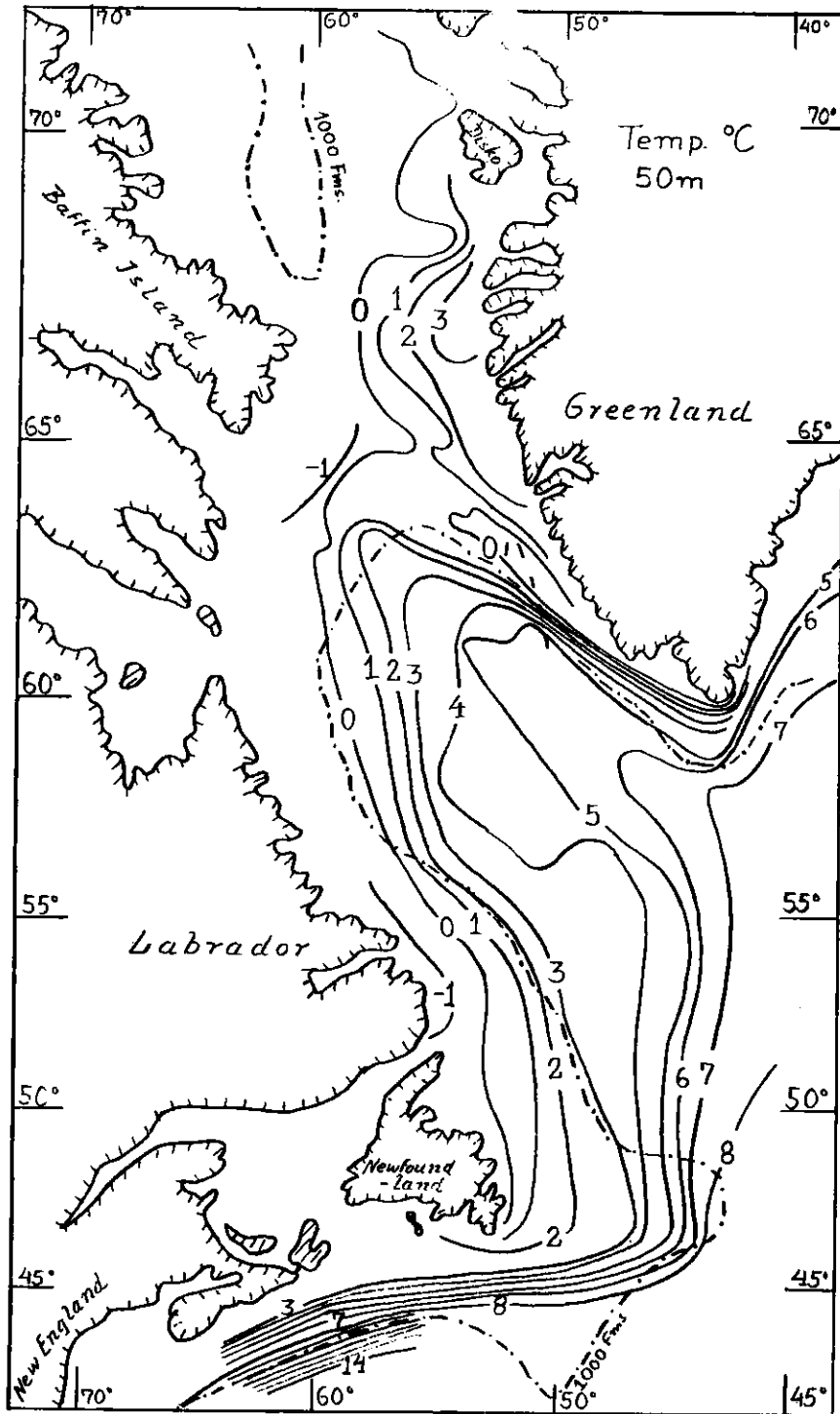

Fig.11 - Isotherms (°C) in 50 m. depth in the Convention Area in July-August 1955.
Compiled from Canadian, Danish and Norwegian sections.

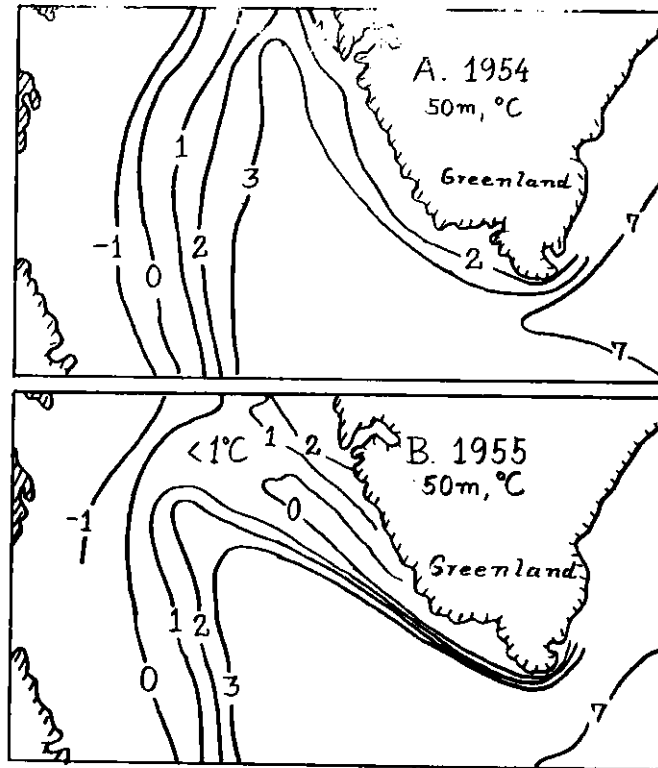

Fig.12 - Isotherms, 50 m., off S. Greenland, 1954 and 1955.
Based on Fig.11 and corresponding figure for 1954.

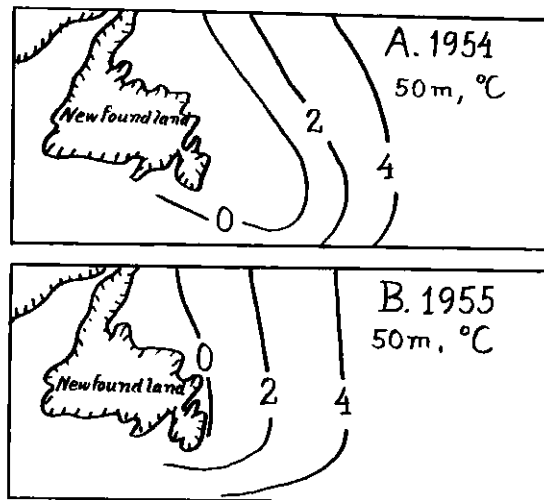

Fig.13 - Isotherms, 50 m., Grand Bank area, 1954 and 1955.
Based on Fig.11 and corresponding figure for 1954.

